

TTL HA-1520 Series

Description

The **HA-1520 Series** of quartz crystal oscillators provide enable/disable 3-state TTL compatible signals for bus connected systems. Supplying Pin 1 of the HA-1520 units with a logic "1" enables its output on Pin 5. In the disabled mode, Pin 5 presents a high impedance to the load. All units are resistance welded in an all metal package, offering RFI shielding, and are designed to survive standard wave soldering operations without damage. Insulated standoffs to enhance board cleaning are standard.

Features

- Wide frequency range— 0.5MHz to 85.0MHz
- User specified tolerance available
- Will withstand vapor phase temperatures of 253°C for 4 minutes maximum
- Space-saving alternative to discrete component oscillators
- High shock resistance, to 3000g
- All metal, resistance weld, hermetically sealed package
- Low Jitter
- High Q Crystal actively tuned oscillator circuit
- Power supply decoupling internal
- No internal PLL avoids cascading PLL problems
- Low power consumption
- Gold plated leads - Solder dipped leads available upon request

Electrical Connection

Pin	Connection
1	Enable Input
4	Grd & Case
5	Output
8	V _{CC}

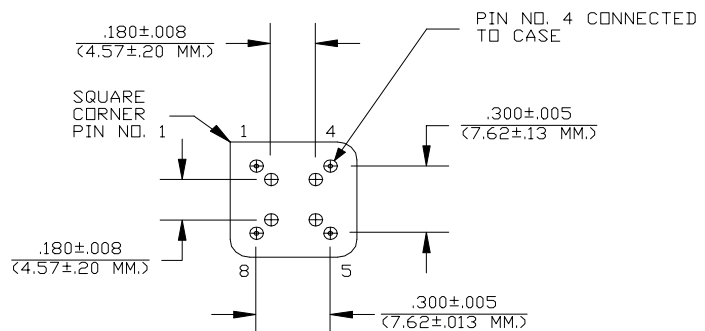
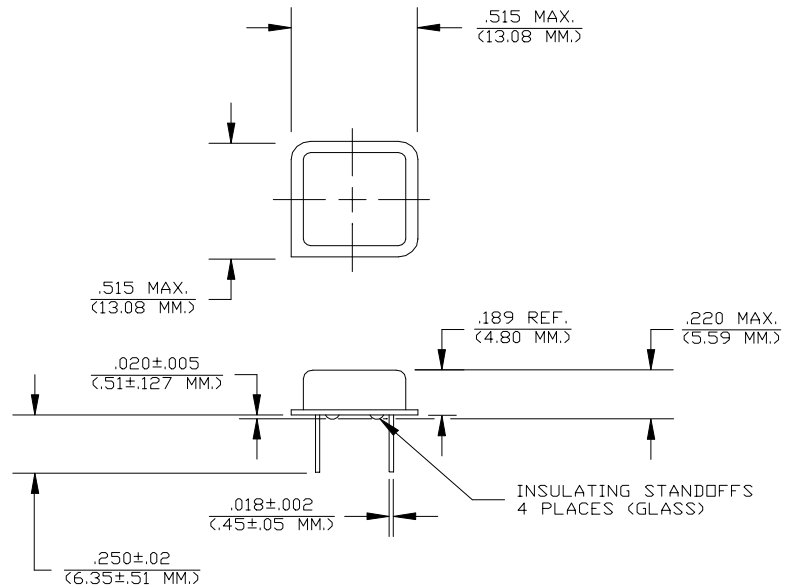

Dimensions are in inches and (MM)

HA-1520 Continued
TTL

Rev. D

Operating Conditions and Output Characteristics

Electrical Characteristics

Parameter	Symbol	Conditions	Min	Typical	Max
Frequency	----	----	0.5MHz	----	85.0MHz
Duty Cycle	----	@ $V_{CC}/2$	40/60%	----	60/40%
Logic 0	V_{OL}	@ 16mA	----	----	0.4V
Logic 1	V_{OH}	@ 0.4mA	2.4V	----	----
Rise & Fall Time	tr,tf	@ 0.4 to 2.4V	----	----	----
		<40MHz	----	----	8 ns
		40MHz or greater	----	----	5 ns
Tapz	----	----	----	----	25 ns
Jitter, RMS ⁽²⁾	----	<40MHz OT & >40MHz	----	----	5 psec
		<40MHz Fund	----	----	8 psec
Frequency Stability ⁽¹⁾	dF/F	Overall conditions including: voltage, calibration, temp., 10 yr aging, shock, vibration	-100ppm	----	+100ppm

General Characteristics

Parameter	Symbol	Conditions	Min	Typical	Max
Supply Voltage	V_{CC}	----	4.75V	5.0V	5.25V
Supply Current	I_{CC}	No Load	0.0 mA	----	50 mA
Output current	I_o	----	0.0 mA	----	±16.0 mA
Operating temperature	T_A	----	0°C	----	70°C
Storage temperature	T_S	----	-55°C	----	125°C
Power Dissipation	P_D	----	----	----	263 mW
Lead temperature	T_L	Soldering, 10 sec.	----	----	300°C
Load	----	----	----	----	10TTL gate
Start-up time	t_s	<20MHz	----	----	2 ms
		20MHz or greater	----	----	10 ms

Environmental and Mechanical Characteristics

Mechanical Shock	Per MIL-STD-202, Method 213, Condition E
Thermal Shock	Per MIL-STD-883, Method 1011, Condition A
Vibration	0.060" double amplitude 10 Hz to 55 Hz, 35g's 55Hz to 2000 Hz
Soldering Condition	300°C for 10 seconds
Hermetic Seal	Leak rate less than 1×10^{-8} atm.cc/sec of helium

Footnotes:

- Standard frequency stability ($\pm 20, \pm 25, \pm 50$ ppm & others available)
- Jitter performance is frequency dependent. Please contact factory for full characterization.

Creating a Part Number	
HA - X152X - FREQ	
Package Code	Tolerance/Performance
HA Ledged 4 pin (8 pin)	0 ±100ppm 0-70°C
SA Ledged 4 pin (8 pin) SMD Gull Wing	1 ±50ppm 0-70°C
	7 ±25ppm 0-70°C
	9 Customer Specific
Input Voltage	A ±20ppm 0-70°C
Code Specification	B ±50ppm -40 to +85°C
A 3.3V	C ±100ppm -40 to +85°C
5V	

Test Load:

